

VARLIE BATH - INSTALLATION

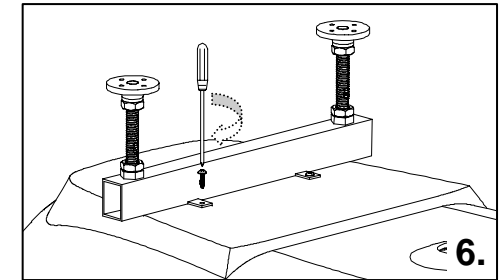

NOTES

- Prior to installation check that all fittings have been supplied.
- Assemble bath on a mat to protect against damage to bath surface.
- Step 10: Bath must be supported by bath legs; not by bath panel. Ensure bath legs come into contact with floor.
- Follow each step in turn.

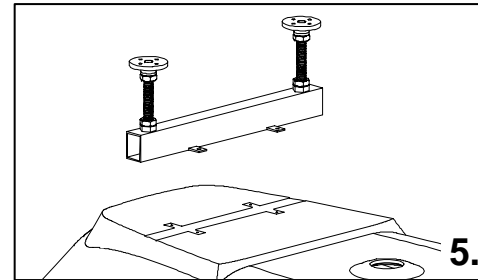
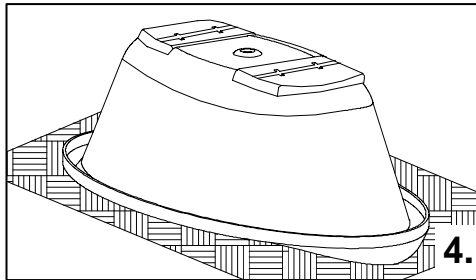
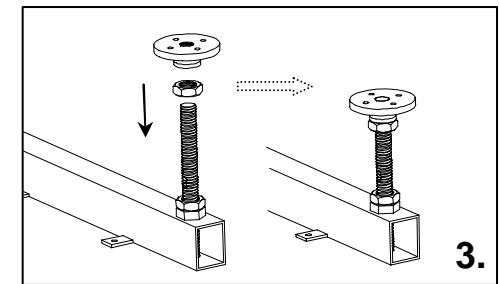
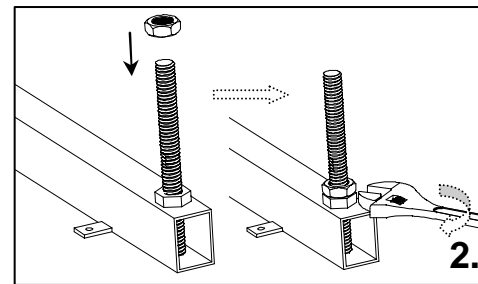
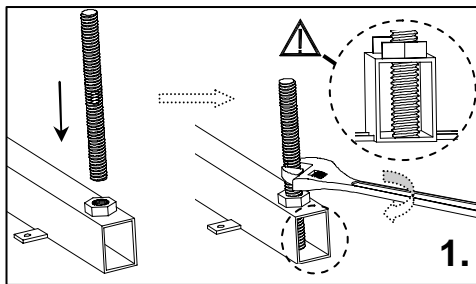
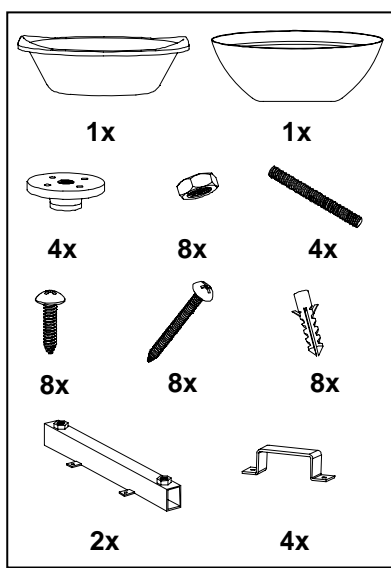
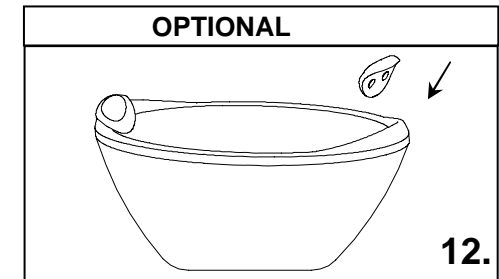
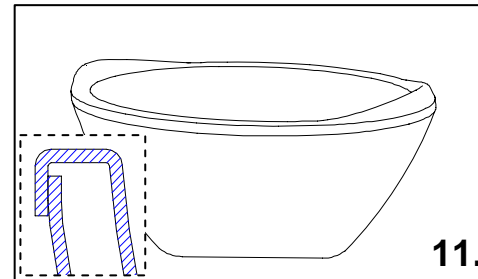
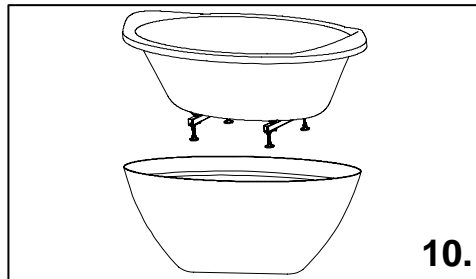
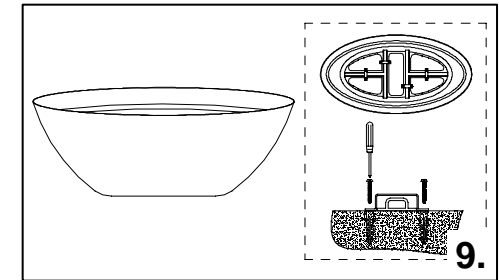
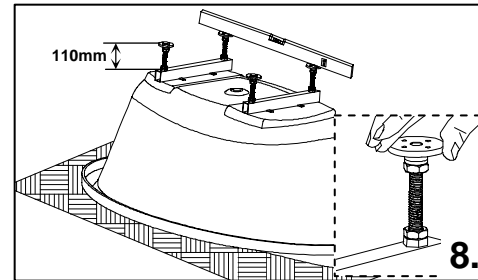
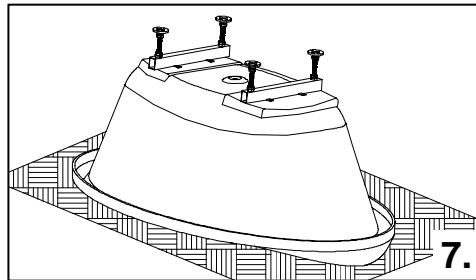

This installation guide does not include details of waste connection; final decision about installation of waste connection should be taken by a suitably qualified person.

VICTORIA
(03) 9768 3577

NEW SOUTH WALES
(02) 9604 1620

SOUTH AUSTRALIA
(08) 8374 0877

NORTHERN TERRITORY
(08) 8947 0019

QUEENSLAND
(07) 3208 9199

WESTERN AUSTRALIA
(08) 9209 2299

NORTH QUEENSLAND
(07) 4723 4511

TASMANIA
(03) 6273 1355